



LOST VAPE®

QUEST



Q-ULTRA AIO KIT

USER MANUAL

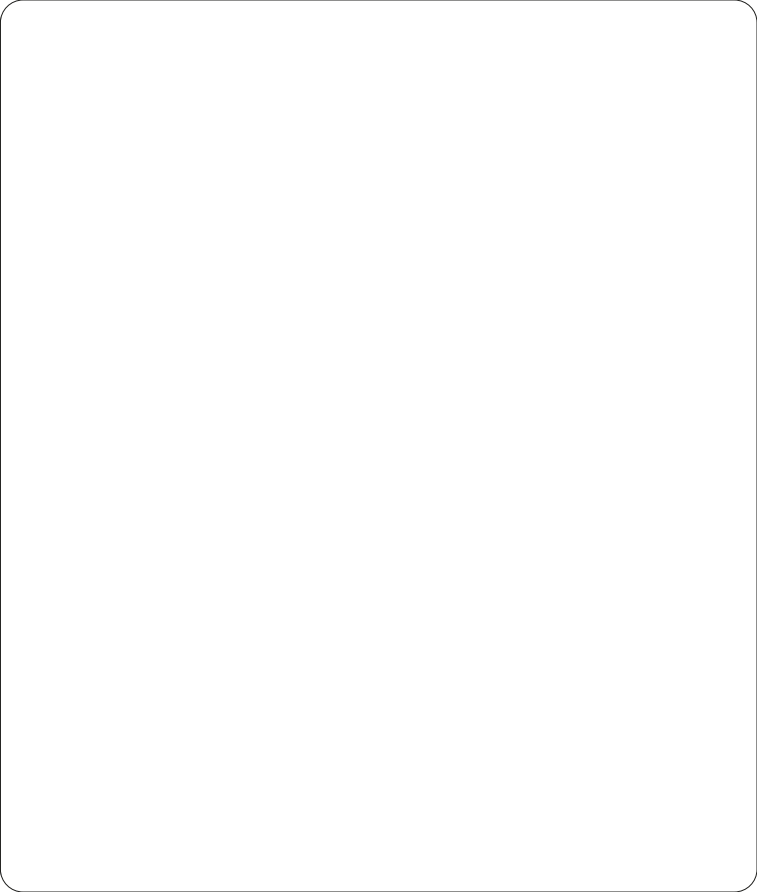



SAFETY WARNING & INSTRUCTIONS

Please read this leaflet carefully before using the product and keep the product in a safe place:

1.Warning For Vulnerable Consumer Groups: The sale and use of e-cigarettes is prohibited for people under the age of 21. The use of e-cigarettes and liquids during pregnancy and breastfeeding, or by a non-smoker is not recommended. Keep this e-cigarette and its components out of the reach from children.

2.Battery Caution: Do not expose the device to extreme temperatures. Do not disassemble the device to service or change the battery without Lost Vape's recommendation. Do not overcharge the batteries. Do not use this product if the battery overheats. Charge the device indoors only. Contact Lost Vape or an authorized repair center for battery servicing. Only dispose of Lithium Polymer batteries at suitable waste disposal facilities.

3.E-liquid Use: To use this product, e-liquid must be filled into the tank/pod as explained below. ONLY E-LIQUIDS WHICH COMPLY WITH EUROPEAN UNION LAW, AND OTHER RELEVANT LAW, SHOULD BE USED IN THIS PRODUCT. Please consult with reputable e-cigarette and e-liquid dealer for advice on what e-liquids can be used in this product.

4. Verify The Authenticity: Please verify that the product is an authentic Lost Vape product before purchasing it. Fake and shoddy products may damage your personal health. To verify the product, please refer to <https://lostvape.com/anti-counterfeit/> and follow the steps described in the New Verification System. If you have any questions, please contact us by email, phone or our website to get help.

5. Pod Cartridge Attention: Do not dry burn the pod or cotton. It is essential to fully saturate the cotton when having filled or refilled an empty pod. Q-ULTRA pods are not covered under warranty once they are opened, used, or filled with liquids.

6.Contacts: For further questions or inquiries, please contact Lost Vape at support@lostvape.com or visit our website: www.lostvape.com.

7.Warranty: The Q-ULTRA device is covered by a 3-month warranty from the date of purchase. Please check our Warranty Guidelines for further information.



RoHS

1 PRODUCT DESCRIPTION

PACKAGE

1× Q-ULTRA KIT(0.6Ω COIL PRE-INSTALLED)
1× TYPE-C USB CABLE
1× WARRANTY CARD

1× ULTRA BOOST 1.0Ω MTL COIL
1× USER MANUAL

BASIC PARAMETERS

DIMENSION	105mm×43.2mm×16.5mm
WEIGHT	90g
POD CAPACITY	4ML/2ML
POWER RANGE	5W~40W
COIL RESISTANCE RANGE	0.15~3.0Ω
BATTERY CAPACITY	1600mAh
TYPE-C USB PORT	5V/1.5A

2 PRODUCT COMPONENTS

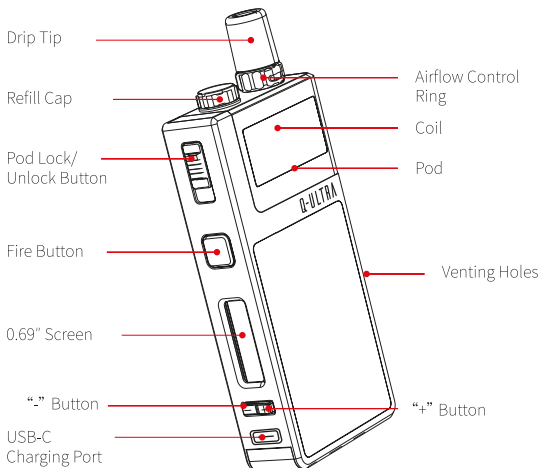

3 BASIC OPERATION OF DEVICE

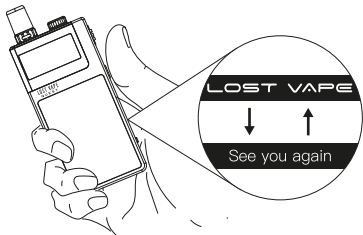

● Power On/Off

Consistently press the Fire button 5 times to turn on/off the device. The screen displays “Lost Vape” once you turn it on, and “See You Again” appears on the screen as you turn it off.

● Wattage lock/unlock

Hold the Fire button and “+” button together to lock/unlock the wattage settings. The screen will display “Locked/Unlock”.

Beware: The Fire button will still work while the wattage setting is locked!

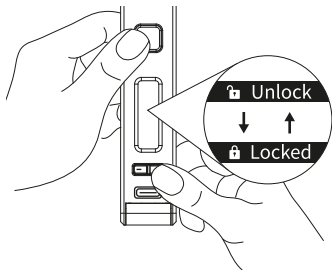

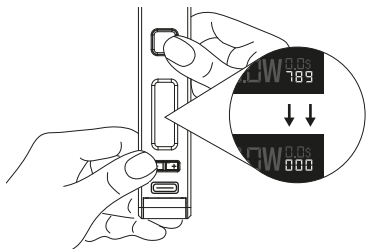

● **Reset Puff Counter**

Hold the Fire button and "-" button together to set the puffs to Zero.

● **Airflow Adjustment**

Twist the airflow control ring to adjust the airflow according to your taste.

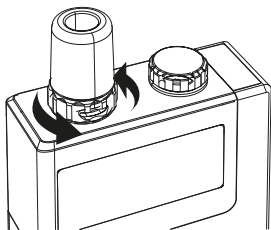

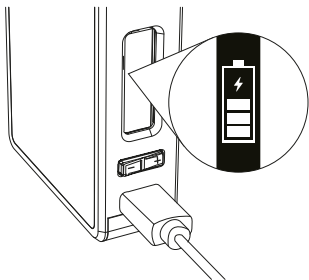

● Charging

Connect the USB-C cable to a power source. The battery icon will begin to animate and stop animating once fully charged.

ATTENTION: Pass-through is not allowed.

4 DEFAULT MAIN INTERFACE OPERATION



① Battery Level



② Coil Resistance



③ Wattage Value



④ Last Vaping Time: The data will be cleared after pressing the Fire Button, and your vaping time will be recalculated.



⑤ Puffs Count (From 000 to 999)

5 SECURITY PROTECTION

Too Hot

●Overheat protection (Once the device temperature beyond 75°C, it will stop working automatically and the screen shows “Too Hot”)

Low Battery

●Low voltage protection (Once the battery voltage below 3.2V, the device will stop working automatically and the screen shows “Low Battery”)

Check Atomizer

●Short circuit protection (Once the device cannot check the pod, the screen shows” Check Atomizer”; Once the resistant of the coil beyond 0.1ohm, when you press the fire button, the screen shows “Short circuit”)

Over 10s

●10 seconds over-time protection (Once you vape over 10s at one time, the device will stop working automatically and the screen shows “Over 10s”)



●Overcharge protection (Once fully charged, the device will stop charging and the screen shows “fully charged icon”).

6 COIL SERIES



Ultra Boost 0.3Ω Mesh Coil

Rate: 30-40W
(*Sold Separately)



Ultra Boost 0.6Ω Mesh Coil

Rate: 20-28W



Ultra Boost 1.0ohm MTL Coil

Rate: 8-15W



Ultra Boost RBA

(*Sold Separately)

7 HOW TO FILL THE E-LIQUID

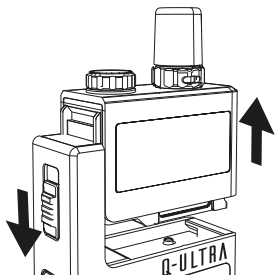

● STEP 1

Slide down the pod lock/unlock button to release the pod, then pull it off the device.

● STEP 2

Remove the protective tape at the first time.

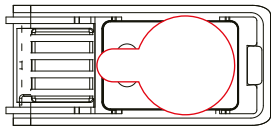

● **STEP 3**

Unscrew to open the refill cap, then fill the e-liquid into the pod. Screw the refill cap once the filling is completed.

ATTENTION: To avoid dry hit, please refill the pod immediately when the level of e-liquid drop to the e-liquid hole. After filling e-liquid into a pod with the new coil, please let the pod stand for 15 minutes to avoid the possibility of coil-burning.

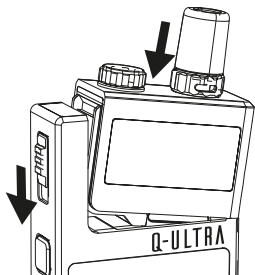
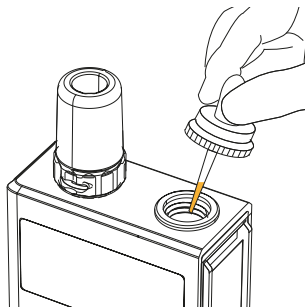

● **STEP 4**

Slide down the pod lock/unlock button, and put the pod in the right place. Then release the button to lock it.

8 HOW TO REPLACE THE COIL

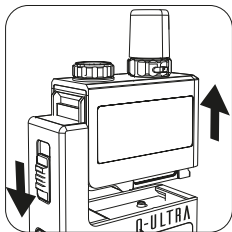

- **STEP 1**
Release the pod.

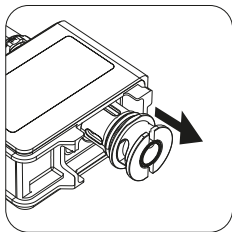

- **STEP 2**
Pull out the old coil directly.

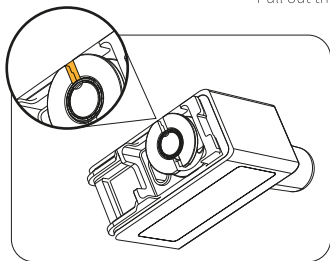

- **STEP 3**
Make the slot be facing on the side of the pod, then align the new coil and insert it into the pod.

WARRANTY REGISTRATION CARD

Please contact support@lostvape.com for mailing address.

Model Number&Name: _____

Package Serial No.: _____

Print Name: _____

Date of Purchase: _____

Store Name: _____

E-mail: _____

Alleged Defects: _____

Return Address: _____

My signature below acknowledges that I have read, fully understand, and accept this limited warranty agreement.

Signature: _____

Date: _____

Please send this card with copy of dated register receipt, and mail support@lostvape.com with the original package to referred address.

Conditions NOT covered under the warranty

- * Warranty is expired
- * Normal wear and tear
- * Damage caused by improper operations
- * Products purchased lower than MSRP or from unauthorized vendor.
- * Accidental damage, faults caused by negligent use, lack of maintenance or neglect it
- * Repairs or alterations carried out by third parties who not in accordance with LOST VAPE QUEST recommendations

3 3-Month
Warranty

from the date of purchase

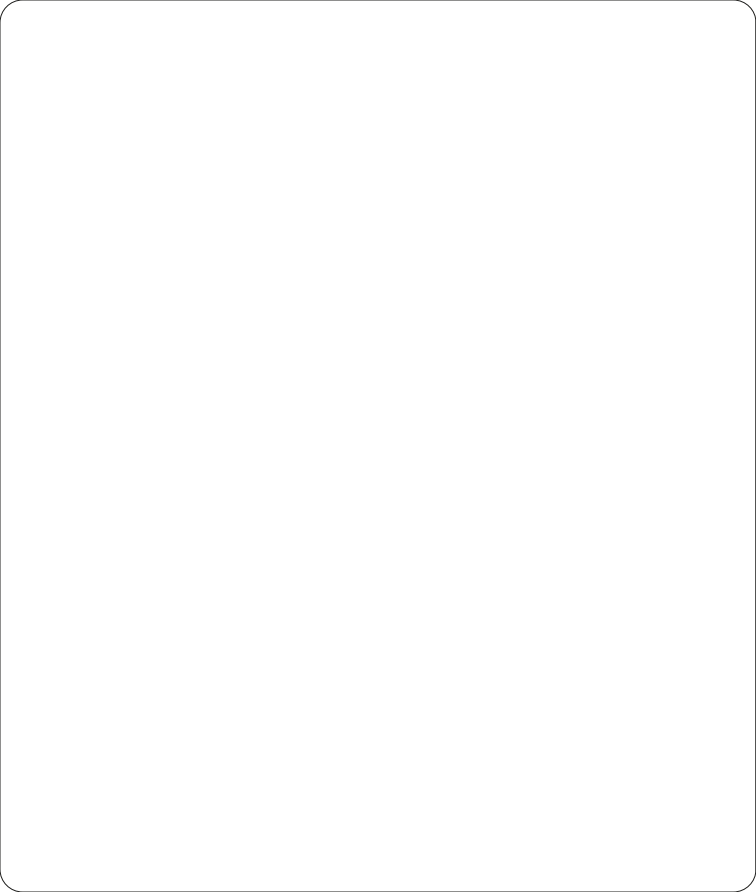



LOST VAPE®
—
QUEST

 www.lostvape.com

 [@lost_vape](https://www.instagram.com/lost_vape)

 [@lostvape](https://www.facebook.com/lostvape)